

ROLA-CHEM[®] Operating Manual

MODEL RC555XXP

Dual ORP/pH/FAC Digital Controller

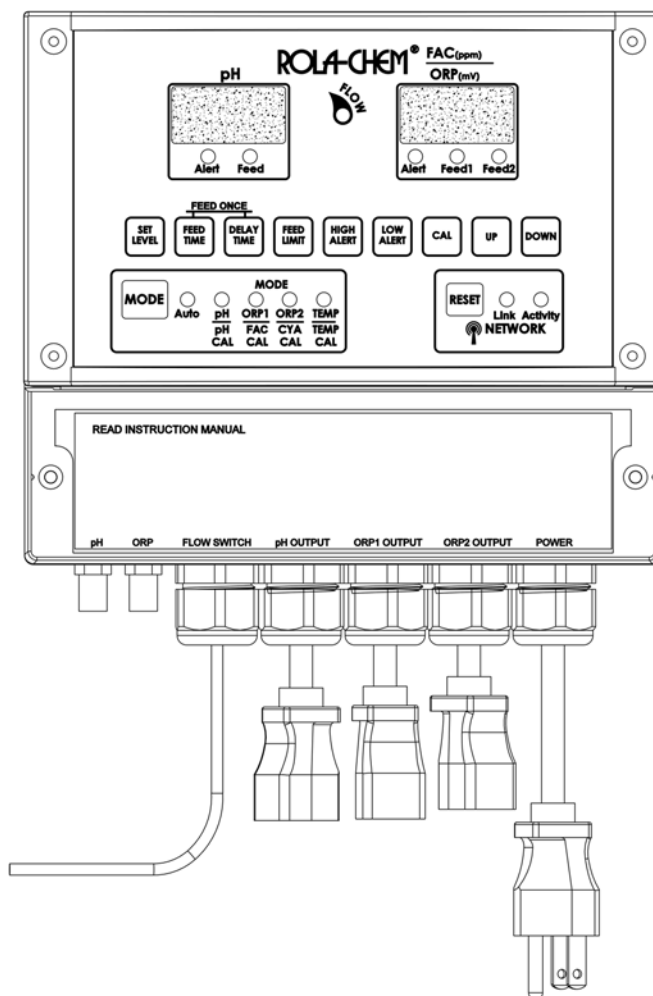

**IMPORTANT SAFETY INSTRUCTIONS
READ AND FOLLOW ALL INSTRUCTIONS
SAVE THESE INSTRUCTIONS**

1. SAFETY: When installing and using this electrical equipment, basic safety precautions should always be followed, including:

1.1 WARNING! To reduce the risk of injury, do not permit children to use this product unless they are closely supervised at all times

1.2 WARNING! Risk of electric shock.

Connect only to a grounding type receptacle protected by a ground-fault circuit interrupter (GFCI). Contact qualified electrician if you cannot verify that the receptacle is protected by a GFCI and that your installation meets local electrical codes, including grounding of water system components.

1.3 WARNING! Risk of electric shock.

Do not bury electric cords. Locate cord to minimize abuse from lawn mowers, hedge trimmers, and other equipment. Replace damaged cords immediately. Do not use extension cords.

1.4 WARNING! Risk of electric shock.

Install at least 10 feet (3.0m) from inside wall of water enclosure using non-metallic plumbing. Do not install this controller in a location accessible to the public.

1.5 WARNING! Risk of Chemical Overdose/Exposure.

Removing power from circulating pump must also remove power from the controller. Provide a properly located outlet controlled by the circulating pump circuit.

1.6 WARNING! Risk of electric shock/pinching/chemical exposure.

Remove power sources or lockout circuit prior to performing maintenance on controller.

1.7 WARNING! Risk of Chemical Overdose/Exposure

Use a device such as a flow switch to shut off power from the controller in the event of circulating pump failure. It is unsafe to automatically dispense chemicals into a circulating system that is not running.

1.8 WARNING! Risk of Chemical Exposure.

Pool water must be balanced and stabilized before operating this controller.

1.9 WARNING! Risk of Chemical Overdose/Exposure

Minimize the amount of chemical on site that is available to dispense.

Size the feeder and container to pool/spa capacity.

Dilute chemical for small bodies of water.

1.10 WARNING! Risk of Chemical Exposure

Do not shut down circulation and control system immediately after using pool, spa or hot tub. Systems must operate until water chemistry is stable. Systems must be restarted before water chemistry is out of NSPI recommended ranges or water chemistry must be manually corrected.

1.11 WARNING! Controller uses microprocessor.

Wireless communication equipment or other electrical devices operated in close proximity may cause inadvertent actuation of chemical feed pumps.

Table of Contents

Section title	Page
1. Safety Instructions	2
2. Quick Start Reference	4
3. Description and Specifications	
3.1 General Description	5
3.2 Specifications	8
3.3 Description of controls	10
4. Installation	
4.1 Locating the controller	15
4.2 Mechanical installation	15
4.3 Power panel access	16
4.3.1 Dip switches	16
4.3.2 Fuses	16
4.3.3 Flow switch	17
4.4 Globe Flowcell	17
4.5 Network connection for ppm value and Remote Monitor	17
4.6 Temperature Probe	18
5. Operation	
5.1 Startup	19
5.2 pH settings	19
5.3 pH Calibration	19
5.4 ORP settings	20
5.5 Calculated Free Available Chlorine (FAC) Calibration	20
5.6 Cyanuric Acid (CYA) Calibration	20
5.7 Temperature Calibration	20
5.8 Operating mode	21
5.9 Website Registration and Setup	21
6. Troubleshooting	22
7. Warranty and Service	25
8. Appendix	
8.1 Dip switch settings	26
8.2 Factory default settings	27
8.3 Water chemistry ranges-NSPI	27
8.4 Consecutive Feed Alert Limit (FEED LIMIT)	28
8.5 Typical system installations	29

2. Quick Start Reference

Use this section for reference. Please read all safety instructions and appropriate manual sections for installation and operation instructions.

- Do NOT add chemicals to feeders until all startup operations are completed.
- Manually adjust and balance pool/spa to acceptable levels and verify using DPD test kit prior to startup. Automation should be used to maintain chemical levels, not to balance a pool/spa that is out of acceptable chemical ranges.

On/Off:

- To turn the unit on press the MODE button. Note: 'FLOW' light must illuminate.
- To turn the unit off press and release MODE button to change to ORP or pH mode. Then press and hold the MODE button. "OFF" will be displayed in the windows.

To Operate:

- Press and release the MODE button until the "AUTO" LED is lighted.
 - Unit will now operate in the factory preset settings:
 - Set levels: ORP1 = 650 mV, ORP2= 640 mV, pH = 7.4
 - Feed times: ORP1 & pH = 10 second feed with a 5-minute delay, ORP2 = OFF
 - Alert Limits: ORP1= 900 high & 100 low, pH= 8.0 high & 7.0 low
- Note: ORP2 limits controlled by ORP1

To Change Settings:

Press and release the MODE button until the desired ORP1, ORP2 or pH LED is lighted. Once the settings are changed, they will remain at those settings until they are changed again.

- Set level: press the SET LEVEL button and use the UP/DOWN buttons to adjust the set point.
- Feed time: press the FEED TIME button and use the UP/DOWN buttons to adjust the set point.

The numbers represent the seconds of feed time (all with associated delay times). Range is 0.6 to 900 sec. (15 min.). Continuous feed is 'con'.
- Delay time: press the DELAY TIME button and use the UP/DOWN buttons to adjust the set point.

The numbers represent the minutes of delay time. Range is 1 to 99 minutes. If set to OFF the delay time will be the default value of 5 minutes.
- High alert: press the HIGH ALERT button and use the UP/DOWN buttons to adjust the set point.
- Low alert: press the LOW ALERT button and use the UP/DOWN buttons to adjust the set point.
- Consecutive Feed Alert Limit: See Appendix 8.4 for adjusting limit.

Manual Feed:

- Press and release the MODE button to light the LED associated with the desired feeder to be manually fed: ORP1, ORP2 or pH.
 - Simultaneously depress the FEED TIME AND DELAY TIME buttons. The desired feeder will go through one set "feed time" cycle.
- There is no manual feed option when the unit is set to Continuous feed or off.

Temperature:

- Press and release the MODE button until Temp (temperature) LED is lighted. Temperature will be displayed in left hand display window and °F or °C will be displayed in right hand window.

Other: See the appropriate manual sections for:

- Calibrating the pH sensor (See section 5.3), Free Available Chlorine (FAC) (See section 5.5), Cyanuric Acid (CYA) (See section 5.6) and Temperature (See section 5.7)
- Ethernet Connection requirements (See section 4.5) and Website Registration and Setup (See section 5.9)
- Changing dip switches (pH/ORP feed interlock, pH/ORP alert interlock and acid/base chemical feed). – See Appendix section 8.1

3. Description and Specifications

3.1 General Description

The controller is a microprocessor-based chemical automation system which continuously monitors and maintains the pH balance and sanitizer level (ORP) in a swimming pool or spa. ORP (Oxidation Reduction Potential) is a measurement of sanitizer effectiveness.

The Dual ORP/pH Digital Controller is intended to control two sanitizer sources, not two bodies of water.

The pH and sanitizer level (ORP) are displayed using sun-bright seven-segment light emitting diodes. The pH and ORP levels are continuously monitored and displayed on the controller's front panel. The ORP/pH controller has been designed to be user friendly. One MODE button and seven SET buttons allow the operator to easily set parameters.

The pH display range is 6.0 to 8.4 with a .01-unit resolution. The pH set point is adjustable from 7.0 to 8.0 in .1 pH steps, with a factory default set point of 7.4 pH. During a pH feed cycle, the pH feed lamp will flash when pH chemicals are being fed and illuminate continuously during the feed delay portion of the feed cycle. The pH Alert lamp will illuminate when the pH reading is higher or lower than the high and low pH Alert set points and prevent the feeding of pH chemicals. The Digital Display numbers will flash and the pump/feeder will not activate if the Set Level is not reached within the preset Consecutive Feed Alert Limit. The default value is 60 cycles for timed feed mode or 60 minutes for continuous feed mode. See appendix 8.4 for setting Consecutive Feed Alert Limit.

The sanitizer (ORP) display range is 0 to 995 mV with a 5 mV display resolution. The ORP1 set point is adjustable from 400 to 900 mV, with default set point of 650 mV. The ORP2 set point is adjustable from 400 to 890 mV, with default set point of 640 mV. The ORP2 will be 10mV or more below the ORP1.

During an ORP feed cycle, the ORP1 or ORP2 feed lamp will flash when sanitizer chemicals are being fed and illuminate continuously during the feed delay portion of the feed cycle. The

ORP Alert lamp will illuminate when the ORP reading is higher or lower than the high and low ORP Alert set points and prevent the feeding of sanitizer chemicals. The Digital Display numbers will flash and the pump/feeder will not activate if the Set Level is not reached within the preset Consecutive Feed Alert Limit. The default value is 60 cycles for timed feed mode or 60 minutes for continuous feed mode. See appendix 8.4 for setting Consecutive Feed Alert Limit.

A manual FEED ONCE feed cycle for pH or ORP can be started by pressing the MODE button (placing the controller in stand-by mode for either pH, ORP1 or ORP2) and then simultaneously pressing the FEED TIME and DELAY TIME buttons.

The feed cycle is a timed based 'feed then delay' system. The controller has a series of fixed feed times (0.6 to 900 sec.) with associated delay time set to 1 – 99 minutes. A feed cycle consists of a feed time plus a delay time. Example: a 30 second feed time followed by a five-minute delay would have a 5½ minute feed cycle. The chemical feeder dispenses chemical only during the feed time portion of the cycle and then waits for a delay period to allow for chemical to disperse throughout the swimming pool or spa. The controller can also be set to continuous feed mode by setting feed time to 'con'.

The controller incorporates an internal non-volatile memory in which all factory default settings as well as field-modified settings are stored. The internal memory is not affected by power interruption and requires no backup battery. Acid/base, pH/ORP feed interlock, and pH/ORP alert interlock switches are located behind the Power Panel Access Cover. See section 4.3

The pH and ORP outputs are capable of handling 3.15 amps each at 120 Volt AC. The relay outputs are fused and transient protected. An internal terminal strip is provided for field wiring of the controller. The internal step-down transformer has a class-two energy limiting rating to provide for electrical safety.

Note: When automating any body of water, it is essential to size the feeders to reach desired levels in a relatively short period of time. Generally, automating an existing body of water with existing feeders will require the output of the feeders be increased accordingly. If feeders are unable to keep up with demand in a short period of time, automation becomes ineffective.

Calculated Free Available Chlorine (FAC) is displayed in parts per million (ppm) when unit is connected to the Rola-Chem remote monitoring website. The FAC value updates on the same time interval as "Update Frequency" set on the remote monitor website. The righthand display will toggle between the current ORP reading and the last calculated FAC. The FAC (ppm) calculated value is not certified to NSF 50.

The Remote Monitor retrieves data from the controller. At a selectable interval the Remote Monitor polls the Controller for current readings. The current date, time, and ORP/pH levels are then reported to a web-based interface.

See section 4.5 for Ethernet Connection requirements

See section 5.9 for Remote Monitor Website Registration and Setup

Available Readings and Features

To see the webpage for a controller, access the Remote Monitor website at <https://monitor.rola-chem.com/> and click on the Controller's Name on the Dashboard.

1. **Readings** tab shows recent data.
 - Readings available on the web-based status page include pH level, pH alert status, ORP level(s), ORP alert status, flow status, controller set points, alerts history and settings history.
2. **Alerts** tab shows alert events.
3. **Settings History** tab shows history of changed settings.
4. **Reports** tab exports PDF or Excel reports for:
 - a. **Level Summary** – summary of average/high/low values over the selected time period.
 - b. **Alert Summary** – summary of alerts over the selected time period.
 - c. **Hourly Levels** - average/high/low values for each hour of the day over the selected time period.
 - d. **Settings** – shows history of changed settings.Data can also be exported to Excel or PDF file from Readings, Alerts and Settings History tabs.
5. **Notifications** tab configures email or SMS (text) messaging notifications.

Notifications can be sent by SMS (text) and/or email if:

 - There is **No Communication** with the website with 12 hours.
 - A **No Flow Alert** event occurs.
 - An ORP, or pH reading exceeds the **High/Low Alert** limits.
 - An ORP, ORP2 or pH Consecutive Feed Limit (CFL) time or cycle count is exceeded.
 - A setting is changed.
 - Temperature is Out of Range set on website.

Standard data fees and SMS (text) messaging rates may apply based on your plan with your mobile phone carrier.

The web-based interface shows fields for readings that may not be active on all controllers.

3.2 Specifications

Parameter	Display	Set Level Range	Factory Default
pH:	6.0 to 8.4	7.0 to 8.0	7.4
ORP:	0 to 995 mV		
ORP1:	(5 mV increments)	400 mV to 900 mV	650mV
ORP2:	(5 mV increments)	400 mV to 890 mV	640mV

Input Power:

120 Volts AC, 50/60 HZ, 3 wire grounded power cord.
Combined load not to exceed 10 amps.
GFCI source required

Output Power:

120 Volts AC, 50/60 HZ, ORP1, ORP2 and pH, 3.15 amps each (fused)
Two 3-wire grounded power receptacles
Terminal strip for hardwire applications (included)

Input/output voltage can be set to 220 Volts AC. Output voltage will be equal to input voltage. **Changing switch position while unit is powered will cause damage.** Consult with factory for proper instruction when changing voltage.

Displays:

ORP and pH - red digital
Power and flow indicator - LED
Alert indicator & Feed indicator - LED (pH, ORP1& ORP2)
Mode indicator - LED (pH, ORP1, ORP2, Auto)

Note: feed lamps flash during the feed time and are on continuously during the delay time of the feed cycle.

Operating Temperature: 40 to 120° F

Selectable Features

+ ORP1& ORP2 settings	+ pH settings	+ Manual feed (Feed Once)
+ ORP1& ORP2 feed/delay times	+ pH feed/delay times	+ pH calibration
+ High & low ORP and pH alerts	+ Reset	+ ORP and pH Interlock
+ Acid/base feed	+ Adjustable Consecutive Feed Alert Limit	

Features and Options

+ Flow switch input	+ Individually fused outputs	+ 120 VAC transformer
---------------------	------------------------------	-----------------------

-Blank page-

3.3 Description of Controls

1- WATER FLOW LAMP

Illuminates brightly when water flow is indicated. Also indicates that power is on.

2- pH/ORP ALERT LAMPS

Illuminates red when the High or Low Alert levels are reached.

3- CHEMICAL FEED LAMPS

pH FEED lamp flashes while feeding chemical and illuminates continuously during feed delay.

ORP1 & ORP2 FEED lamp flashes while feeding chemical and illuminates continuously during feed delay.

4- pH/ORP DIGITAL DISPLAYS

Monitors pH / ORP / FAC and displays programmed set points.

The Digital Display numbers will flash if Consecutive Feed Alert Limit is exceeded.

5- pH STANDBY LAMP AND PROGRAMMING BUTTONS

When pH standby lamp is illuminated the set buttons are enabled.

6- MODE BUTTON AND AUTOMATIC LAMP

Press MODE button to pH or ORP and then hold for 2 seconds for OFF.

Press and release MODE button to step from pH standby to ORP1 / ORP2 standby and TEMP.

Press again to return to AUTOMATIC mode.

7- ORP STANDBY AND PROGRAMMING BUTTONS

When ORP1 lamp is illuminated the five SET buttons are enabled.

When ORP2 lamp is illuminated the three SET buttons are enabled.

8- pH/ORP SENSOR CONNECTORS - BNC type

9- HIDDEN UP/DOWN LOCK BUTTON

There is a hidden button 3/8" below the "FLOW" light. Press and hold for 3 seconds to toggle lock on/off.

10- NETWORK RESET BUTTON

11- NETWORK STATUS LAMPS

12- TEMPERATURE MODE LAMP

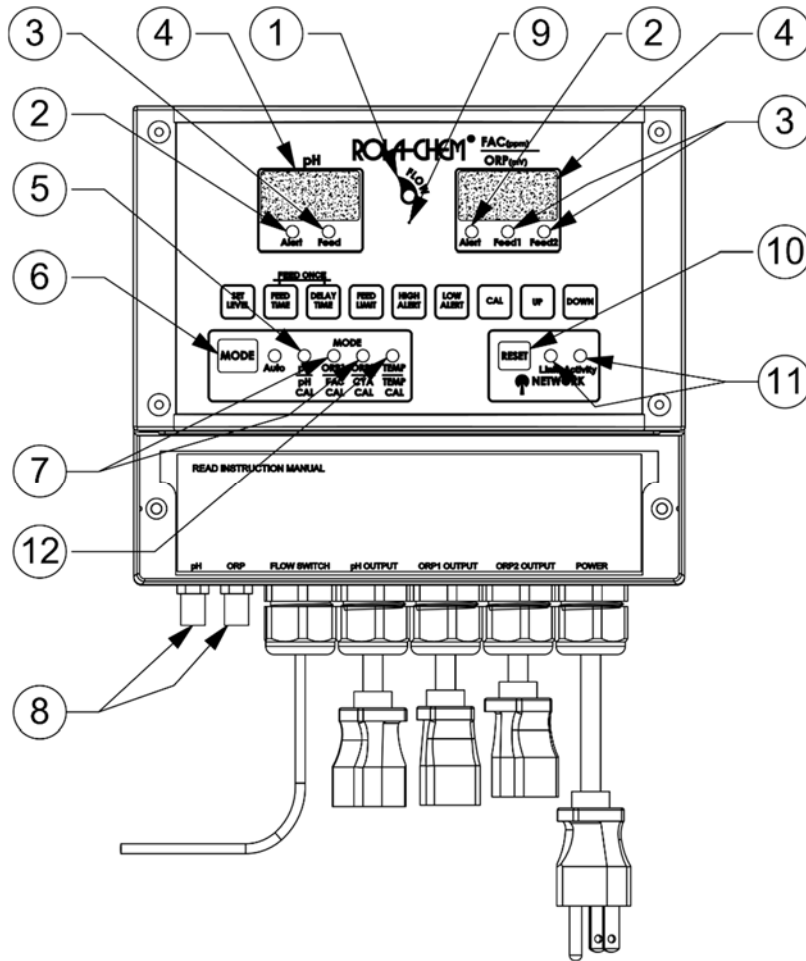

Modes: The controller has five modes of operation:

- ON/OFF mode.
- AUTO mode- normal operation mode
- pH - setting mode
- ORP1 - setting mode
- ORP2 - setting mode

To move from one mode to another simply press the MODE button. The illuminated lamp indicates the current mode.

3.3.1 On/off mode:

- To turn the controller “ON” press the MODE button.
- To turn the controller “OFF” press to change MODE to pH or ORP and hold the MODE button for two seconds until both displays read “OFF”. Release the MODE button and the controller turns off and the displays go blank.

Note: Turning the controller “OFF” using the MODE button simply turns off the controller functions but does not turn off the power to the controller. The ‘FLOW’ lamp located at the center of the controller is both the power light and a flow indicator when an optional flow switch is used.

3.3.2 AUTO mode: This is normal operation mode. The controller operates the respective feeders to automatically maintain the parameters set for both pH and ORP.

3.3.3 pH mode: This enables the programming buttons to set the desired pH parameters.

Set Level: Pressing the SET LEVEL button will display the current set level. To adjust the set point (which can be adjusted in 0.10 pH increments) use the UP/DOWN buttons until the desired level is reached.

Note: The controller will overshoot the pH Set Level by 0.20 to reduce on/off cycles.

Feed Time: The feed times are displayed in seconds.

Each feed cycle includes an adjustable feed time and an adjustable delay time which is five (5) minutes by default. Pressing the FEED TIME button allows the user to scroll through the available feed times by using the UP/DOWN buttons. To set the controller to Continuous feed, set the feed time to “con”.

Continuous feed runs feeder continuously; (1) until set point is reached or (2) until Consecutive Feed Alert Limit is reached or (3) until High/Low Alert limit is reached. See appendix 8.4 for Consecutive Feed Alert Limit details. Feed time can also be set to “off”.

Delay Time: The delay times are displayed in minutes.

Pressing the DELAY TIME button allows the user to scroll through the available delay times by using the UP/DOWN buttons. If set to OFF the delay time will be the default value of 5 minutes.

Feed Once Feature:

- To initiate a manual feed cycle, press and release MODE button to light the pH LED.
- Simultaneously depress the FEED TIME and DELAY TIME buttons. The pH feeder will go through one set feed time and delay time cycle. If the Feed time is set for “Continuous feed” the manual feed will not operate.

High Alert: Pressing the HIGH ALERT button allows the operator to set or turn off the High Alert level feature. Use the UP/DOWN buttons to scroll through the available High Alert pH levels (7.5 to 8.4 and off). The High Alert cannot be turned off in the BASE feed selection.

Low Alert: Pressing the LOW ALERT button allows the operator to set or turn off the Low Alert level feature. Use the UP/DOWN buttons to scroll through the available Low Alert pH levels (6.8 to 7.4 and off). The Low Alert cannot be turned off in the ACID feed selection.

Note: If the pH reading is out of the pre-set alert range for more than ten (10) minutes the pH red alert lamp will illuminate and the pH feeder will be disabled. The system will automatically reset when the water chemistry has been corrected.

CAL (Calibrate pH): Allows the operator to calibrate the pH sensor to a buffer or to a sample tested with a test kit. Pressing the CAL button while in pH mode allows the operator to adjust the pH reading to match the buffer or test kit value using the UP/DOWN buttons.

Note: The sample to be tested should always be taken from the flow cell or container in which the pH sensor is located. The pH calibration allows the adjustment of +/- 1 pH in .1 pH increments.

Consecutive Feed Alert Limit (FEED LIMIT): The Digital Display numbers will flash and the pump/feeder will not activate if the Set Level is not reached within the preset Consecutive Feed Alert Limit. See appendix 8.4 for more details.

3.3.4 ORP1 mode: This enables the programming buttons to set the desired ORP parameters.

Set Level: Pressing the SET LEVEL button will display the current set level. To adjust the set point (which can be adjusted in 5 mV increments) use the UP/DOWN buttons until the desired level is reached.

Note: The controller will overshoot the ORP Set Level by 10mV to reduce on/off cycles.

Feed Time: The feed times are displayed in seconds.

Each feed cycle includes an adjustable feed time and an adjustable delay time which is five (5) minutes by default. Pressing the FEED TIME button allows the user to scroll through the available feed times by using the UP/DOWN buttons. To set the controller to Continuous feed, set the feed time to “con”.

Continuous feed runs feeder continuously; (1) until set point is reached or (2) until Consecutive Feed Alert Limit is reached or (3) until High/Low Alert limit is reached. See appendix 8.4 for Consecutive Feed Alert Limit details. Feed time can also be set to “off”.

Delay Time: The delay times are displayed in minutes.

Pressing the DELAY TIME button allows the user to scroll through the available delay times by using the UP/DOWN buttons. If set to OFF the delay time will be the default value of 5 minutes.

Feed Once Feature:

- To initiate a manual feed cycle, press and release MODE button to light the ORP LED.
- Simultaneously depress the FEED TIME and DELAY TIME buttons. The ORP feeder will go through one set feed time and delay time cycle. If the Feed time is set for “Continuous feed” the manual feed will not operate.

High Alert: Pressing the HIGH ALERT button allows the operator to set or turn off the High Alert level feature. Use the UP/DOWN buttons to scroll through the available High Alert pH levels (660 mV to 910 mV, preset at 900 mV).

Low Alert: Pressing the LOW ALERT button allows the operator to set or turn off the Low Alert level feature. Use the UP/DOWN buttons to scroll through the available Low Alert pH levels (100 mV to 630 mV in 5 mV increments and “OFF”).

Note: If the ORP reading is out of the pre-set alert range for more than ten (10) minutes the ORP red alert lamp will illuminate and the ORP feeder will be disabled. The system will automatically reset when the water chemistry has been corrected

Consecutive Feed Alert Limit (FEED LIMIT): The Digital Display numbers will flash and the pump/feeder will not activate if the Set Level is not reached within the preset Consecutive Feed Alert Limit. See appendix 8.4 for more details.

CAL (Calibrate FAC): Allows the operator to calibrate the Calculated Free Available Chlorine (FAC) reading to a sample tested with a test kit. Pressing the CAL button while in ORP1 mode allows the operator to adjust the FAC reading to match the test kit value using the UP/DOWN buttons.

3.3.5 ORP2 mode: This enables the programming buttons to set the desired ORP2 parameters. ORP2 control parameters are the same as ORP1 except that ORP2 set level will be 10mV or more below OPR1.

CAL (Calibrate CYA): Allows the operator to calibrate the Cyanuric Acid (CYA) value to a sample tested with a test kit. Pressing the CAL button while in ORP2 mode allows the operator to adjust the CYA value to match the test kit value using the UP/DOWN buttons. CYA in the water will affect the ORP reading and the related Calculation of the FAC reading.

3.3.6 TEMP mode: Displays water temperature if temperature sensor is installed.

- Temperature reading does not change while in temperature mode. Cycle through all modes and back to temperature to see changes.
- To calibrate temperature press the UP/DOWN buttons while in TEMP mode. Temperature can be calibrated +/- 10 degrees.
- To toggle temperature units Fahrenheit/Celsius press the CAL button while in TEMP mode.

Note: NSF certification of this unit includes the pH and ORP sensors only.

3.3.7 Hidden UP/DOWN BUTTON LOCK FEATURE: UP/DOWN buttons can be locked to prevent unauthorized changes to settings.

- There is a hidden button 3/8" below the "FLOW" light between the display readouts.
- To toggle the lock on/off place the controller in pH or ORP mode and then press and hold the hidden button for 2 seconds until "Loc On" or "Loc Off" is displayed. With the lock set to "On" the UP/DOWN buttons do not operate. All other buttons work allowing current settings to be displayed.

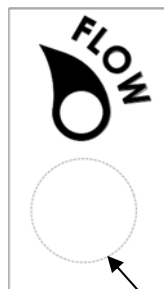

Hidden Lock Button below "FLOW" light

4. Installation

4.1 Locating the Controller

Install the chemical pump and erosion feed systems as shown in manuals included with the feeders. The controller may need to be set for the particular feeder system used. Before installing the controller, it is important to do a site assessment to consider where and how you will mount the unit. The controller should be mounted on a wall or other surface within eight feet of the feeder, at least ten feet away from the edge of the water, and within six feet of the GFCI power source. Never mount a controller above or near an acid tank. Never mount a controller in a location accessible to the public. Install the controller in an area protected from natural elements (sun, rain, freezing, etc.). See appendix for typical feed system schematics.

4.2 Mechanical Installation

Once the site is selected, obtain screws or anchors (mounting screws are not provided with controller) to securely mount the controller on the wall or a panel. Install a screw in the wall/panel where the top center of the controller is to be located. Leave $\frac{1}{4}$ inch of the screw out of the wall to hang the controller from the keyhole located on controller's back. Remove the power panel access cover and install screws through the two holes located at the bottom left and right corners of the controller.

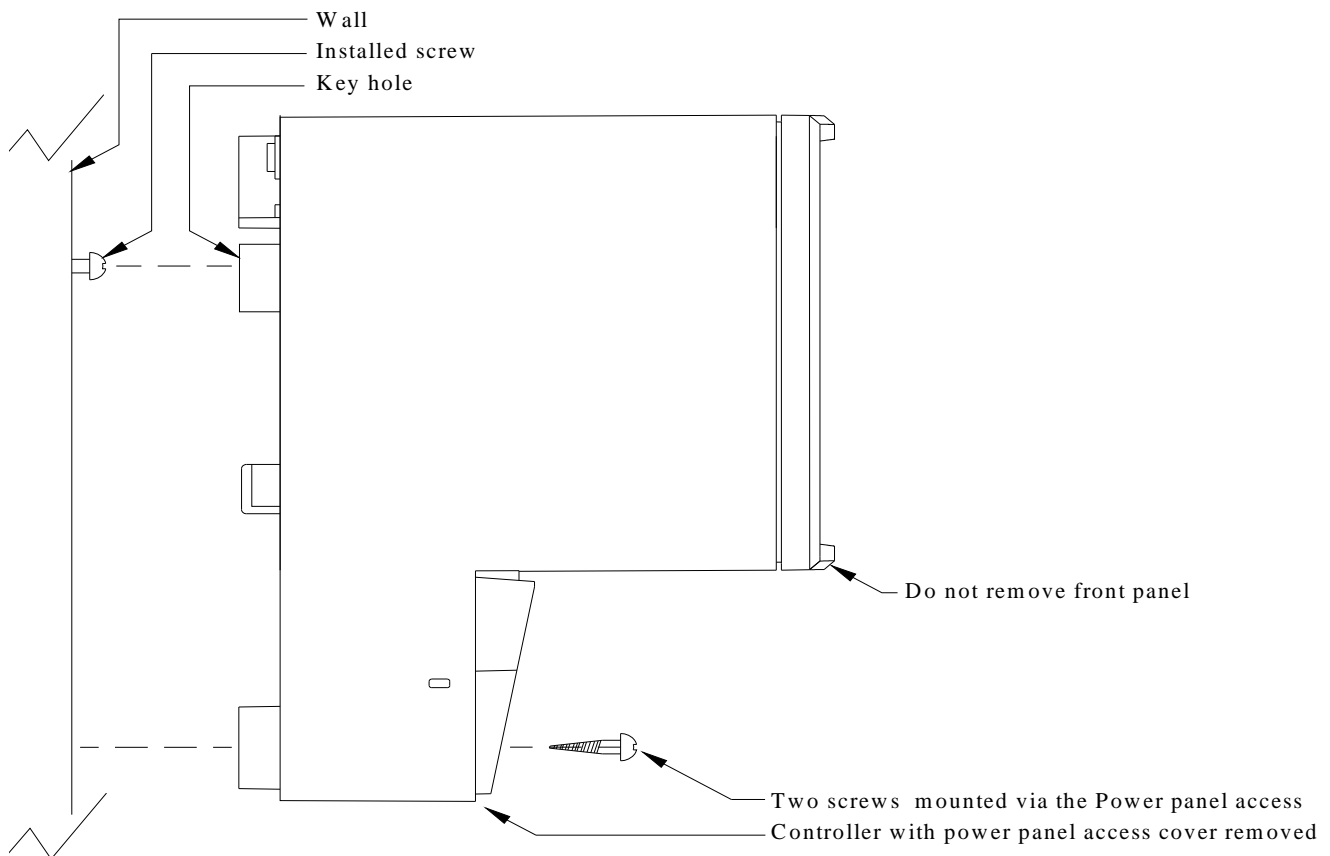

4.3 Power panel access

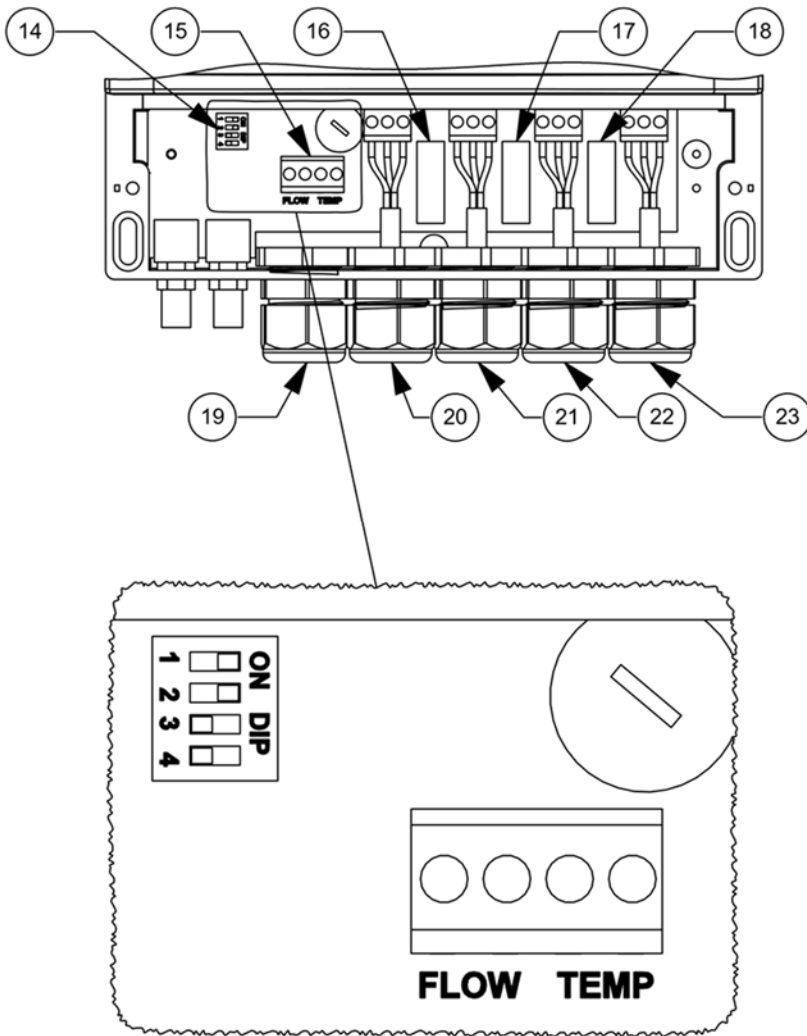

- 14. DIP SWITCH ARRAY
- 15. FLOW SWITCH AND TEMPERATURE PROBE TERMINAL
- 16. pH FUSE
- 17. ORP 1 FUSE
- 18. ORP 2 FUSE
- 19. FLOW SWITCH, ETHERNET CABLE AND TEMPERATURE INPUT
- 20. pH OUTPUT
- 21. ORP 1 OUTPUT
- 22. ORP 2 OUTPUT
- 23. EXTERNAL POWER INPUT

4.3.1 Dip switches

The controller has a series of dip switches to control functions that are not normally accessible on the front panel. These dip switches are located inside the Power panel. To access switches, remove power from the controller and remove power panel access cover. There are four dip switches- #1 is the top switch. The switch is 'off' when in the left position and 'on' in the right position. See appendix 8.1 for settings.

4.3.2 Fuses

The ORP and pH are independently fused to protect the controller from defective feeders. These fuses are located inside the lower panel. The fuse holders are shipped with 3.15 amp fuses. Replacement fuses are 5mm x 20mm Fast Acting IEC.

4.3.3 Flow Switch

The controller has a flow switch terminal located inside the Power Panel Access Cover on the left side. It is shipped with a jumper in place. The terminal must either have the jumper or a flow switch installed.

The flow switch light on the face of the controller is also a power light that shows that the controller is connected to a live power source. If the terminal does not have a closed circuit, the controller will not power the attached chemical feeders.

NSF certification of this automated controller requires the use of a flow switch. To install a flow switch, remove the jumper and install the flow switch leads. Note: with the flow switch installed and the jumper removed, the flow light will no longer operate as a power light. It is recommended the jumper be retained to assist in troubleshooting if necessary.

4.4 Globe Flowcell (see Globe Flowcell Operating Manual)

Connect the Globe Flowcell grounding stud to ground in order to prevent erroneous readings and to prevent damage to the probes.

Note: It is recommended that an inline filter be used to help keep the flowcell (including probes) and flow switch free from debris. Debris may cause obstruction in flow switch and prevent the switch from functioning.

4.5 Ethernet network connection for calculated ppm value and Remote Monitor

A hardwired Ethernet connection with unrestricted internet access must be provided in order to display and record calculated Free Available Chlorine (FAC) and for the Remote Monitor to function. The Remote Monitor cannot be configured with a hardcoded/static IP address, and it must obtain an IP address from a DHCP server on the customer's network (i.e. from a router or other device which provides DHCP services). There cannot be usernames or passwords required to pass through a firewall or router to get to the web. A simple test for this is to connect a laptop computer to the Ethernet jack and verify (with Wi-Fi turned off) that the laptop can access the web.

Each Controller has a unique MAC address that is required for website setup. This address can be seen on the top of the Controller case and inside the front panel of the enclosure on the communication module. There is also a copy of the MAC address label included with the product literature in a bag labelled "Keep This Bag For Reference". Locate the MAC address and keep it for use in section 5.9 Website Registration and Setup.

Connect the included Ethernet cable to the Ethernet connection noted above.

The Remote Monitor starts collecting data every 60 seconds as soon as it is connected to the internet and powered. This data includes any settings changes or alerts that occur after

connection is made. No data is stored when there is no internet connection. Data is refreshed every 60 seconds until Remote Monitor Module is associated with an account on the website or 30 minutes has elapsed, then the refresh frequency is automatically changed to refresh every 1800 seconds (30 minutes). Refresh frequency can be changed from the Dashboard as follows: click Settings – Controllers and select the controller to be changed. Change the Update Frequency and click Save. The frequency will not change until the current update cycle is complete.

The Network interface includes two internal LED lights and one Reset button. These lights are used to verify network connectivity and the presence of a server connection.

The green LED indicates an active connection between the Remote Monitor and the local network. If the green LED does not light, check the Ethernet cable connections and confirm that the network equipment is functioning correctly. A simple test for this is to connect a laptop computer to the Ethernet port which is to be used for the Remote Monitor and verify (with Wi-Fi turned off) that the laptop can access the internet.

The amber LED indicates activity between the Remote Monitor and the network. The amber LED flashes frequently (every few seconds) when data is being communicated to the Monitoring website. If the amber LED flashes only intermittently (more than 10 seconds between flashes) then the connection to the internet is not working properly.

The Reset button is used to force the network connection to reconnect to the server if the connection is lost. Disconnecting power from the controller will also accomplish this.

See section 5.9 for Remote Monitor Website Registration and Setup

Note: ROLA-CHEM® does not assume responsibility for providing or troubleshooting internet access hardware.

4.6 Temperature Probe

- For use in pipe sizes 1-1/2” and larger.
- Drill a 3/8” inch hole after the filter and before the heater.
- Insert the temperature sensor into the drilled hole and secure with a band clamp (included).
- Run the sensor cable into the controller through the strain relief marked “Flow Switch” and connect to the terminal block on the front circuit board marked “temp”.

5. Operation

5.1 Startup

Do not add chemicals to the feeders until all startup operations are completed. Using a DPD test kit, manually adjust and balance the water chemistry to acceptable ranges. Automation should be used to maintain chemical levels, not to balance a pool that is far out of acceptable ranges. With the controller in the OFF mode, turn the filter pump on and check for leaks in the system and flow through the flow cell. The flow lamp will be illuminated if the controller has power, it is connected to the flow switch and there is adequate flow. If a flow switch is not attached, the flow lamp will be illuminated if there is a jumper in the Flow Switch Terminal allowing the controller to be used without a flow switch. Using a flow switch is always recommended.

A properly installed and functioning flow switch will disconnect power to chemical feeders if there is no water flow in the circulation plumbing. Test flow switch monthly by closing left-hand valve on Flowcell and confirming that the flow light turns off. Then re-open valve and confirm that light turns back on.

5.2 pH settings

Press and release the controller MODE button until the pH LED is lighted (refer to the description of controls). Then select the desired Set Level, Feed Time, High and Low alert levels. Adjust Consecutive Feed Alert Limit (FEED LIMIT) if Set Level is not met within preset limit as indicated by the Digital Display flashing. –See appendix 8.4 for detail.

Note: Controller can be set to feed acid or base. See Acid/Base pH chemical feed section in Appendix 8.1 for Dip switch settings. To verify that acid feed mode is selected adjust the pH set level below the pH indicated on the display. The feed lamp should come on if the controller is in acid feed mode. To verify that base mode is selected adjust the pH set level above the pH indicated on the display. The feed lamp should come on if the controller is in base feed mode.

5.3 pH Calibration

The pH sensor can drift slightly over time and calibration will offset this drift. Always calibrate using water from the sample port of the flow cell and use an independent pH test method to determine pH value of sample, unless using preset buffer solution. Press and release the controller MODE button until the pH CAL (pH) LED is lighted (refer to the description of controls). Then use the UP/DOWN buttons to adjust the value to match known pH value of sample. It may take up to 24 hours for the sensors to acclimate to the system so recalibrate 24 hours after the first calibration. The pH sensor calibration should be checked every four to six weeks. If calibration is required more often than probe may need cleaning or replacement.

5.4 ORP settings

Press and release the controller MODE button until the ORP LED is lighted (refer to the Description of Controls section). Then select the desired Set Level, Feed Time, High and Low Alerts. Adjust Consecutive Feed Alert Limit (FEED LIMIT) if Set Level is not met within preset limit as indicated by the Digital Display flashing. –See appendix 8.4 for details.

The ORP display indicates the effectiveness of the sanitizer; it does not directly correlate to a chlorine ppm reading. To determine your ORP set level, manually adjust and balance the pool to be within acceptable ranges. Use a DPD test kit to confirm the free chlorine level. Use the ORP reading of the balanced pool as your ORP set level.

5.5 Calculated Free Available Chlorine (FAC) Calibration

Many variables can cause the calculated FAC value to vary. Calibrate frequently using a chemical test kit to assure accurate readings. Press and release the controller mode button until the FAC CAL (ORP1) LED is lighted then use the UP/DOWN buttons to adjust the value match the test kit value.

The default FAC CAL value is 0.0 ppm. It can be calibrated in increments of 0.1 ppm. It will not change if the controller is not connected to the monitoring website.

Setting FAC CAL to 'OFF' resets the calibration offset to 0 and disables the FAC display. To restart the FAC display press and release the controller mode button until the FAC CAL (ORP1) LED is lighted then press the UP button once.

FAC (ppm) will be calculated on the website using pH, ORP, temperature and CYA. It will be displayed on the controller and the website. The FAC value updates on the same time interval as "Update Frequency" set on the remote monitor website.

Note: The Free Available Chlorine (FAC) calculation is not certified to NSF 50.

5.6 Cyanuric Acid (CYA) Calibration

The concentration of CYA in the water has a significant role in the calculation of FAC. Test the CYA concentration using a chemical test kit at least monthly and enter the tested value using the following procedure.

Press and release the controller mode button until the CYA CAL (ORP2) LED is lighted then use the UP/DOWN buttons to adjust the value match the test kit value.

5.7 Temperature Calibration

Press and release the controller mode button until the TEMP CAL (TEMP) LED is lighted then use the UP/DOWN buttons to adjust the temperature value (+/- 10 degrees).

Note: NSF certification of this unit includes the pH and ORP sensors only.

5.8 Operating mode

Press and release the MODE button until the “AUTO” LED is lighted. This is the operational mode for the controller. The controller must be in this mode for the feeders to maintain the desired parameters. Each time the Controller mode is changed to Auto, all outputs that are calling for feed will turn on simultaneously for one full feed cycle regardless of Dip Switch #1 setting.

Note: When using an automatic controller with ROLA-CHEM[®] pumps, the pump switch should be in the CONTINUOUS position (not Timed or Off).

If the sanitizer level is too low or high, adjust the ORP set level up or down in small increments, (for example 10mV to 25 mV increments) to lock in the desired sanitizer level.

Note: the ORP reading is highly dependent on both the pH and the cyanuric acid levels. Both of these variables must be kept within acceptable ranges to maintain an acceptable relationship between the ORP and the ppm of the sanitizer.

Note: Low feed rates can cause the feeder to lag or feeding to be extended. A high feed rate can result in too much chemical being added.

If using time feed cycle, the feed lamp will flash during the feed time and be lighted continuously during the delay time of the feed cycle. If over feeding is occurring, consider using a shorter feed cycle.

In Continuous feed, the feed lamp will flash while feeding.

When an alert lamp is on indicating readings below or above the alert settings the pump/feeder will not activate. The Digital Display numbers will flash and the pump/feeder will not activate if the Set Level is not reached within the preset Consecutive Feed Alert Limit. See appendix 8.4 for adjusting Limit.

5.9 Website Registration and Setup.

Calculated ppm value function and Remote Monitor functions require website registration and setup.

Please read all safety instructions and appropriate manual sections for installation and operation instructions.

- a) To install hardware see section 4.5 Ethernet network connection.
- b) To set up monitoring website see <http://www.rola-chem.com/manuals/new2016/554413-RC554M-Website-Registration-Setup-Instructions.pdf>
- c) To see the webpage for a controller that has been set up, access the Remote Monitor website at <https://monitor.rola-chem.com/> and click on the Controller's Name on the Dashboard.

Additional Users

Additional users can be authorized to view an existing Remote Monitor.

Authorized users will need to have an account using an email address. See “Website Registration and Setup Instructions” at ROLA-CHEM®.com.

To add authorized user(s) and give them access to your controller, go to **Settings – Locations** and select a location – select **Change Settings** for the desired controller – click **Add User** under **Authorized Users** section. Complete the **Add User** pop-up using the email address that was used to create the authorized users account. The controller that you authorized will show up automatically when they log into that account.

Checking **Set Notifications** allows the authorized user to set or change notifications.

Note: User assumes responsibility for confirming that pool/spa is properly maintained. Monitor will not provide notification of pool/spa conditions if internet communication fails.

6. Troubleshooting

6.1 Chemicals not feeding

- * FLOW light on Controller must be illuminated.
Check flow switch in Globe Flowcell if light is not on.
- * Feeder power and time switches must be in ‘CONTINUOUS’ position.
Check feeder by using alternate power source.
- * Factory setting for feed time is 0.6 sec on with 5-minute delay.
Feeders may require longer feed time.
- * Chemical reading has met Set Level.

6.2 Displayed chemical level does not correspond to actual level

- * ORP=0, pH=6.0 indicates sensors (probes) are attached to incorrect connector
- * Sensors (probes) need cleaning. (see Globe Flowcell Operating Manual)
- * Sensors (probes) need replacing.
Note: ORP probe reading can be affected by a failing pH probe.
Both probes must be in good operating condition.
- * Calculated FAC ppm value not matching chemical test kit value:
 - 6.2.1 – As pH and ORP probes age calibrate FAC to match test kit ppm value by changing mode to ORP1 (FAC) and using the UP/DOWN buttons to adjust.
 - 6.2.2 – Measure cyanuric acid using test kit and calibrate the CYA value by changing the mode to ORP2 (CYA) and using the UP/DOWN buttons to adjust.
CYA should be tested and entered at least monthly.
 - 6.2.3 – Older water with accumulated contaminants or newer water with contaminants from startup conditions may indicate a lower ORP value for a given chlorine concentration. These conditions may cause inaccurate FAC readings.
Liquid chlorine shock treatment or water replacement may be needed to correct this condition.
- * Ground loop issue. Connect Globe Flowcell ground stud to ground. (see Globe Flowcell Operating Manual)

6.3 Set Level not being reached/maintained

- * Factory setting for feed time is 0.6 sec on with 5-minute delay. Feeders may require longer feed time. If time is too short, set points will not be maintained. If feed time is too long, overfeeding chemicals may occur. Correct time is dependent on multiple factors such as pool/spa water volume, feeder output, chemical concentration and chemical needs.
- * Factory setting for Consecutive Feed Alert Limit (FEED LIMIT) is 60 cycles for timed feed mode or 60 minutes for continuous feed mode. If set level has not been reached within this adjustable limit the Digital Display numbers will flash and pump/feeder will be disabled. If set level cannot be met within this limit then a higher limit may be required. See appendix 8.4 for adjusting Limit. If Limit is set too high, overfeeding chemicals may occur.
- * Controllers are designed to maintain set-points. Do not expect controllers to make major adjustments—major changes should be done manually.
- * Pump/feeders must be large enough to reach desired set-points in a relatively short time. Automation using controllers may require larger feeder or more concentrated chemicals than system that uses continuous time controlled feeding (i.e. feeders only).

6.4 Error Code displayed

If an error code appears in the display the controller can be reset by following this procedure.

- A. Disconnect power to controller.
- B. Simultaneously depress and hold SET LEVEL and CAL buttons.
While they are depressed, reconnect power to controller.
The displays will read “Ld” on the left side and firmware version value on the right side and then turn On.
- C. Release the buttons.
- D. The controller is now in test mode. Test mode reduces the feed delay time from 5 minutes to 5 seconds to simplify diagnostics.
- E. Turn the controller Off to exit test mode.
Press MODE to ORP or pH.
Hold MODE button until display reads “oFF”.
Release the MODE button. Only the flow light should be on.
- F. Press MODE to turn the controller On and return to operating mode.

The last two steps are extremely important because this puts the controller back in operating mode. If these two steps are not performed the controller will remain in test mode and it will not operate properly.

If the error code continues to appear contact ROLA-CHEM[®] service personnel.

6.5 Digital Display numbers flashing

- * Consecutive Feed Alert Limit has been reached. See appendix 8.4 for Consecutive Feed Alert Limit details.
- * Adjust feed time as needed.

6.6 Alert light illuminated

- * High/Low alert limit has been reached.
- * Adjust feed time or alert settings as needed.

6.7 FEED ONCE feature does not work

- * FEED ONCE feature will not operate if the feed time is set for “Continuous feed”.
- * FEED ONCE feature will not operate if controller is in auto Mode. Controller must be in ORP or pH mode.

6.8 Globe Flowcell / Probe / Flow Switch troubleshooting

- * See Globe Flowcell operating manual.

6.9 Up/Down buttons not working.

- * Hidden Up/down button lock feature set to “ON”. To toggle the lock on/off place the controller in pH or ORP mode and then press and hold the hidden button for 2 seconds until “Loc On” or “Loc Off” is displayed. Set to “OFF” to restore button function.

6.10 ORP display not toggling to show FAC.

- * Setting FAC CAL to ‘oFF’ disables the FAC display. To restart the FAC display press and release the controller mode button until the FAC CAL (ORP1) LED is lighted then press the UP button once.

7. Warranty and Service

Limited Warranty:

ROLA-CHEM® warrants the original purchaser that this unit is free from manufacturing defects in material and workmanship from the date of the original purchase for five (5) years.

If this unit fails within the five (5) year period it will be repaired or replaced (ROLA-CHEM® option) at no charge when returned to ROLA-CHEM® with proof of purchase receipt. This warranty does not apply to any product damage caused by improper use, accident, misuse, improper line voltage, fire, flood, lightning, earthquake, other acts of nature, or if product was altered or opened by anyone other than qualified ROLA-CHEM® personnel.

Effective date for this limited warranty – January 1st, 2019.

All expendable items (probes, flow switch, flow cell, valves, feeders, tubing, etc.) are not covered under this warranty.

Heavy duty probes are warranted from the date of original purchase for one (1) year.

ROLA-CHEM® under no circumstances shall be liable for any consequential damages directly or indirectly caused by this unit. Please observe all rules and regulations required by state and local regulations, building codes, health codes, OSHA, etc.

Service Procedure: For operation assistance in the United States please call: (800) 549-4473 and ask for Customer Service, Monday through Friday 8:00 am-5:00 pm Central Time or email: info@rola-chem.com. Have model number and serial number available.

ROLA-CHEM® has specialized knowledge and equipment to test and diagnose your product. Contact our service personnel as noted above for assistance. If you are directed to ship the product to ROLA-CHEM® and given an RGA#, please note RGA# on the package and ship freight pre-paid to:

ROLA-CHEM®
5858 Centerville Road
St. Paul, MN 55127-6804

www.rola-chem.com

8. Appendix

8.1 Dip switch settings

The controller has dip switches to control functions/options that are not accessible on the front panel. These dip switches are located inside the power panel access cover. Slide switch right for ON or left for OFF. See section 4.3.

Switch #1 OPR/pH feed interlock

#1 OFF - ORP chemical will feed whether pH feeding or not.

#1 ON factory setting – ORP chemical will not feed when pH chemical is feeding.

Note: Each time the Controller mode is changed to Auto, all outputs that are calling for feed will turn on simultaneously for one full feed cycle regardless of Dip Switch #1 setting.

Switch #2 OPR/pH alert interlock

#2 OFF - ORP chemical will feed whether pH is in alert mode or not.

#2 ON factory setting – ORP chemical will feed only when pH is within set alert limits.

Note: Switch #2 does not disable the Consecutive Feed Alert on this model as on other models. See appendix 8.4 for Consecutive Feed Alert Limit details.

Switch #3 Acid/Base pH chemical feed

#3 OFF factory setting – Unit set to feed acid chemical when pH is over set level.

#3 ON – Unit set to feed base chemical when pH is under set level.

Switch #4 – no function on this controller.

8.2 Factory Default Setting

Reset: The controller can be reset at any time to the default factory settings.

The factory presets are:

ORP1 Set level: 650mV

ORP1 Feed time: 10 seconds

ORP1 Delay time: 5 minutes

ORP2 Set level: 640mV

ORP2 Feed time: Off

ORP2 Delay time: 5 minutes

ORP Alerts: high- 900 mV, low- 100 mV

pH Set level: 7.4

pH Feed time: 10 seconds

pH Delay time: 5 minutes

pH Alerts: high- 8.0, low- 7.0

Consecutive Feed Alert Limits: 60 cycles for timed feed mode or 120 minutes for continuous feed mode

FAC: 0.0 ppm

Button lock: OFF

Note: Record current settings before performing reset.

To reset factory default settings, follow these steps:

A. Press MODE to ORP or pH.

Hold MODE button until display reads "oFF".

Release the MODE button. Only the flow light should be on.

B. Simultaneously depress and hold SET LEVEL and CAL buttons.

While the SET LEVEL and CAL buttons are depressed, press the MODE button.

The displays will read "Ld" on left side and firmware version value on right side and then turn On.

C. Release the buttons.

D. The controller is now in test mode. Test mode reduces the feed delay time from 5 minutes to 5 seconds to simplify diagnostics.

E. Turn the controller Off again to exit test mode.

F. Turn the controller On to return to operating mode.

The last two steps are extremely important because this puts the controller back in operating mode. If these two steps are not performed the controller will remain in test mode and it will not operate properly.

8.3 Water Chemistry Ranges

(These ranges are in accordance with suggested NSPI Standards for swimming pools.)

pH: 7.4-7.6

Alkalinity: Approx. 80-120 ppm ** (parts per million)
Higher levels may be acceptable in areas where it naturally occurs in the local water supply.
Consult a pool professional in your area.

Cyanuric Acid: 0-50 ppm.
Maintain at 30 ppm or less for best probe life.*

TDS (Total Dissolved Solids): 300-2000 ppm

Calcium Hardness: 200-400 ppm

Free Chlorine: 1.0-3.0 ppm (> 700 mV ORP)

*20-30 ppm of cyanuric acid provides approx. 95% of the shielding effect for chlorine.

**When using tri-chlor, recommended alkalinity is 95-125 ppm.

8.4 Consecutive Feed Alert Limit (FEED LIMIT)

Setting consecutive feed alert limit to OFF voids NSF certification. If limit is set too high, overfeeding may occur.

Timed feed Mode (Feed time set to a value other than “con” or “off” on Controller front panel)

The pH and ORP chemical feeder outputs go through a preset number of consecutive feed cycles before feeders are disabled. If preset count is reached for either pH or ORP, the respective feeder outputs will be disabled and its display will flash indicating a Consecutive Feed Alert.

The Consecutive Feed Alert cycle limit can be set from 20 to 100 cycles (default is 60) or ‘off’ and can be independently set for both pH and ORP.

Continuous feed Mode (Feed time set to “con” on Controller front panel)

The pH and ORP chemical feeder outputs continuously for a preset time before feeders are disabled. If the preset time period is reached for either pH or ORP, the respective feeder output will be disabled and its display will flash indicating a Consecutive Feed Alert.

The Consecutive Feed Alert Limit period can be set from 20 to 180 minutes or “off” (default is 120) and can be independently set for both pH and ORP.

To adjust the FEED LIMIT press and release the MODE button until the desired pH or the ORP LED is lighted. Then press the FEED LIMIT button and adjust the value using the UP/DOWN buttons.

Note: The Consecutive Feed Alert cycle limit will be reset to the default values if Feed Time is changed to “con” and will not automatically return to previous set value.

8.5 Typical System Installation

TYPICAL SODIUM HYPOCHLORITE FEED SYSTEM

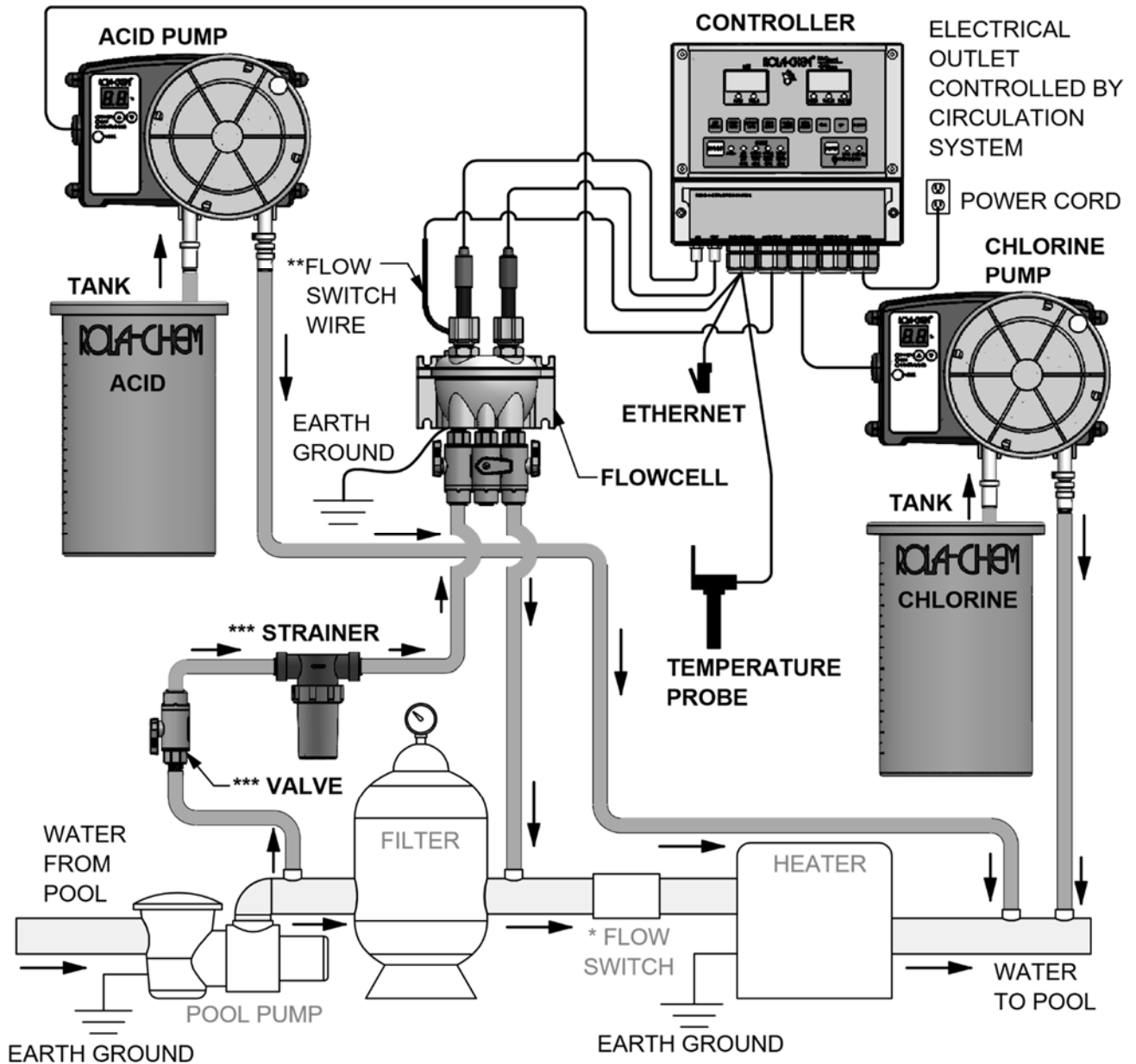

* SAFETY FLOWSWITCH FOR PROTECTION OF HEATER AND TO ENSURE DILUTION OF CHEMICAL INTO POOL.

** SAFETY FLOWSWITCH TO ENSURE CIRCULATION TO CONTROL PROBES AND INDICATORS THAT POOL CIRCULATION IS OCCURRING.

*** OPTIONAL STRAINER AND VALVE TO HELP KEEP MANIFOLD AND PROBES CLEAR OF DEBRIS.

PARTS LABELED IN BOLD ARE AVAILABLE THROUGH ROLA-CHEM.

8.5 Typical System Installations, cont.,

TYPICAL SYSTEM USING ELECTROLYTIC CHLORINE GENERATOR WITH SODIUM HYPOCHLORITE BACK-UP FEED SYSTEM (REFER TO SPECIFIC INSTRUCTIONS FROM CHLORINE GENERATOR)

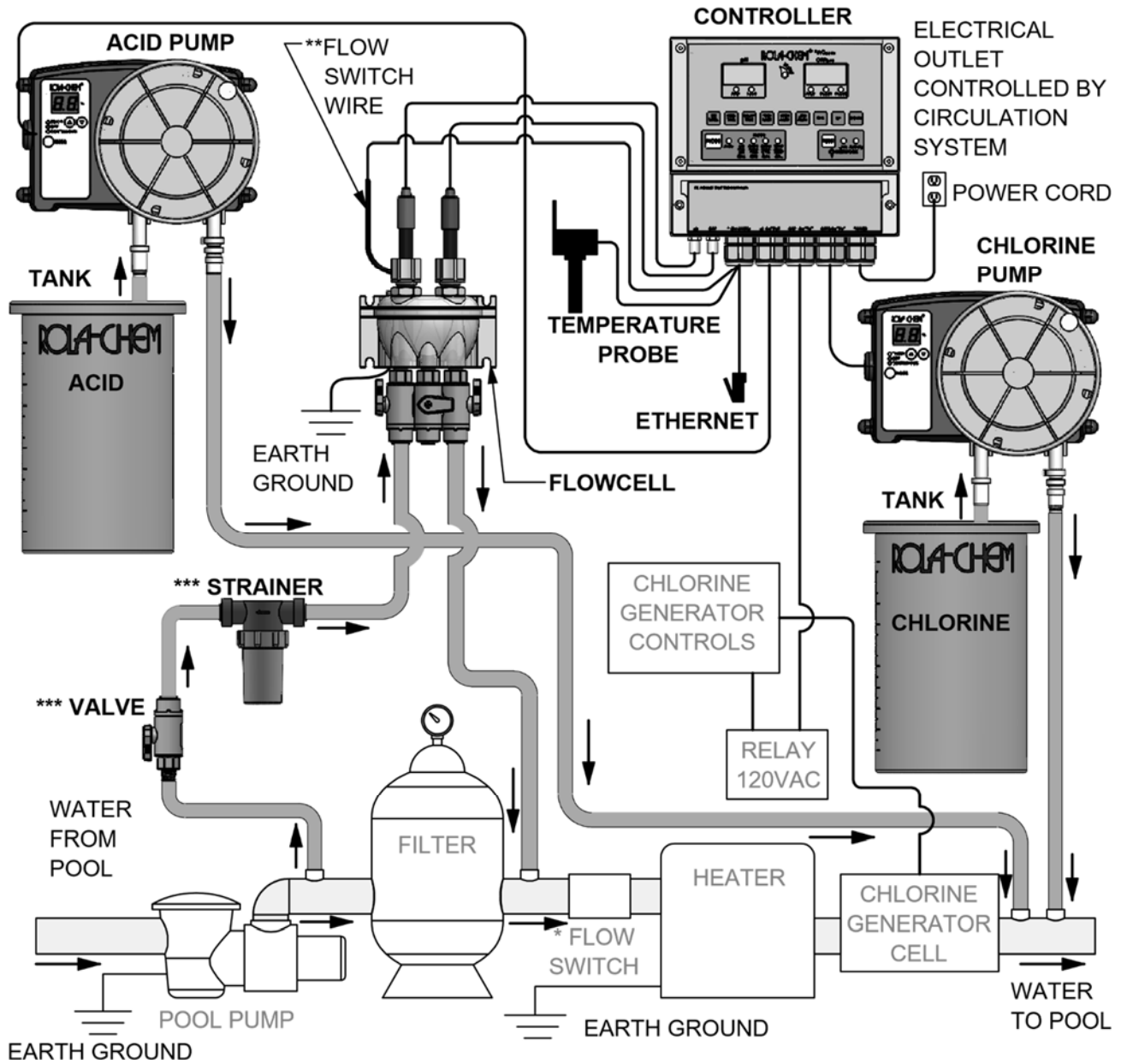

* SAFETY FLOWSWITCH FOR PROTECTION OF HEATER AND TO ENSURE DILUTION OF CHEMICAL INTO POOL.

** SAFETY FLOWSWITCH TO ENSURE CIRCULATION TO CONTROL PROBES AND INDICATORS THAT POOL CIRCULATION IS OCCURRING.

*** OPTIONAL STRAINER AND VALVE TO HELP KEEP MANIFOLD AND PROBES CLEAR OF DEBRIS.

PARTS LABELED IN BOLD ARE AVAILABLE THROUGH ROLA-CHEM.

8.5 Typical System Installations, cont.,

TYPICAL EROSION FEEDER WITH SODIUM HYPOCHLORITE BACK-UP FEED SYSTEM (REFER TO SPECIFIC INSTRUCTIONS FROM EROSION FEEDER)

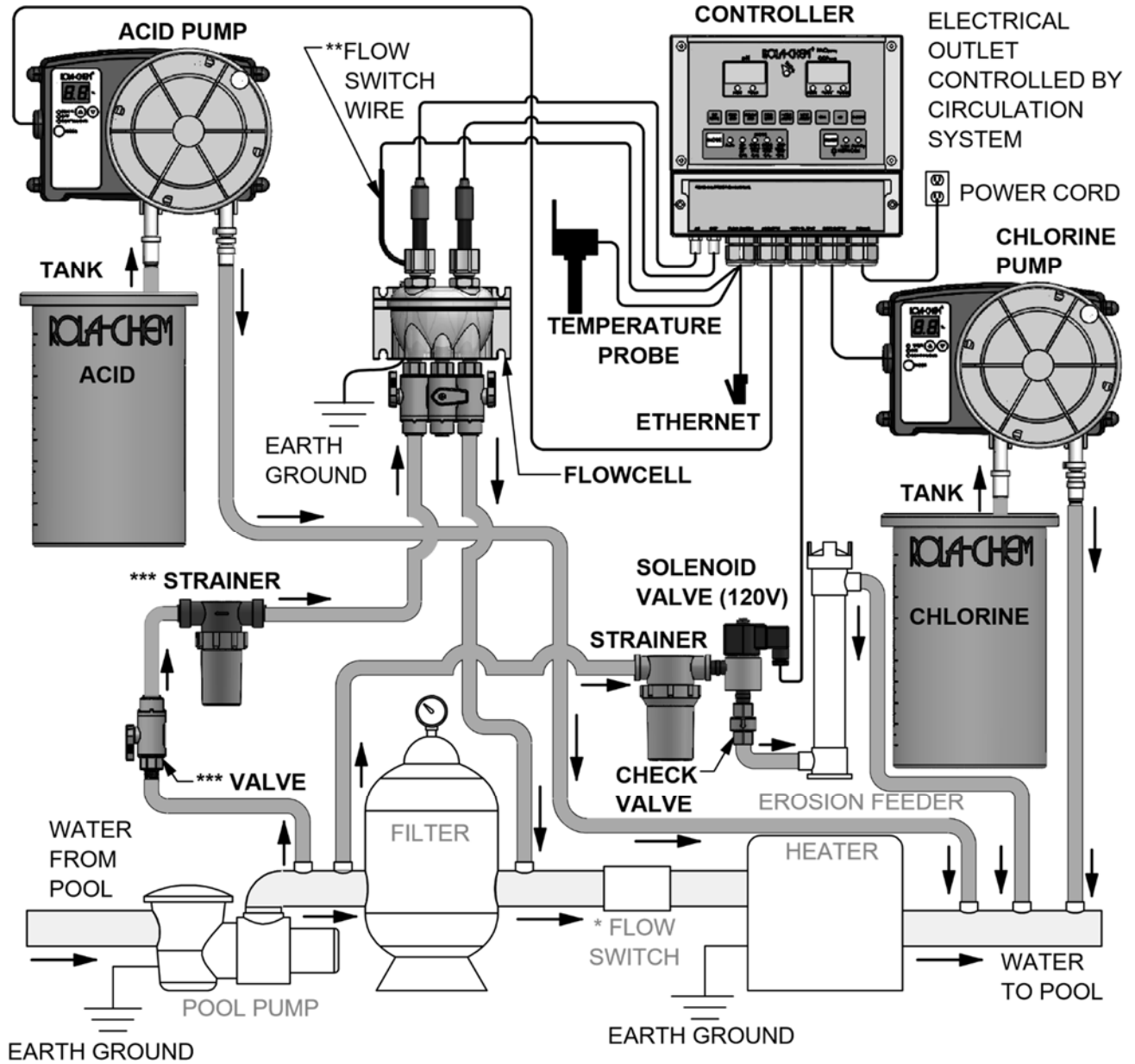

* SAFETY FLOWSWITCH FOR PROTECTION OF HEATER AND TO ENSURE DILUTION OF CHEMICAL INTO POOL.

** SAFETY FLOWSWITCH TO ENSURE CIRCULATION TO CONTROL PROBES AND INDICATORS THAT POOL CIRCULATION IS OCCURRING.

*** OPTIONAL STRAINER AND VALVE TO HELP KEEP MANIFOLD AND PROBES CLEAR OF DEBRIS.

PARTS LABELED IN BOLD ARE AVAILABLE THROUGH ROLA-CHEM.

8.5 Typical System Installations, cont.,

ALTERNATE TO TYPICAL FLOWCELL CONNECTION LOCATION
(USE IF SUGGESTED LOCATIONS DO NOT CREATE ENOUGH PRESSURE
DIFFERENTIAL TO ACTUATE THE FLOW SWITCH OR IF FILTERED WATER IS DESIRED)

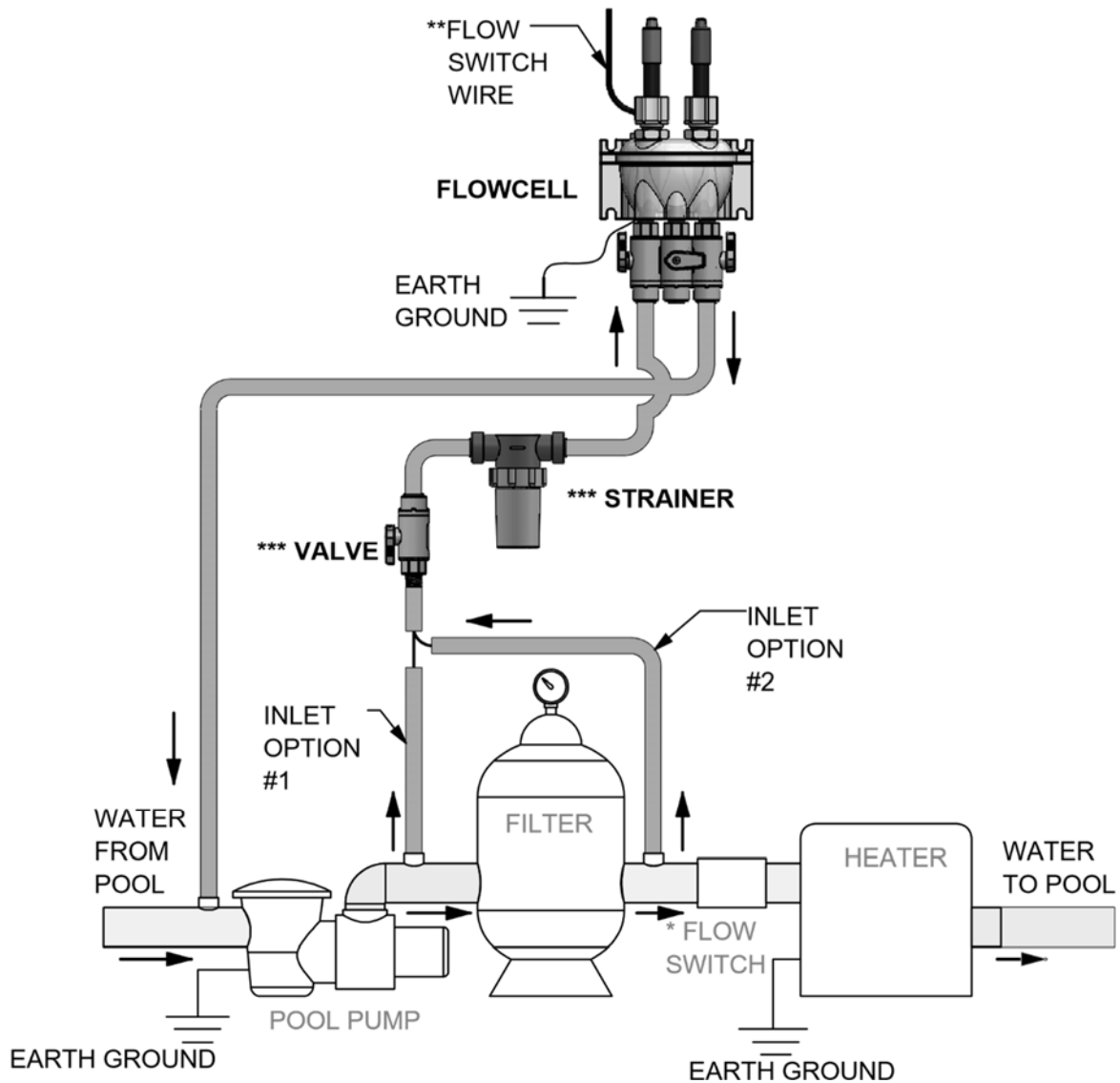

* SAFETY FLOWSWITCH FOR PROTECTION OF HEATER AND TO ENSURE DILUTION OF CHEMICAL INTO POOL.

** SAFETY FLOWSWITCH TO ENSURE CIRCULATION TO CONTROL PROBES AND INDICATORS THAT POOL CIRCULATION IS OCCURRING.

*** OPTIONAL STRAINER AND VALVE TO HELP KEEP MANIFOLD AND PROBES CLEAR OF DEBRIS.

PARTS LABELED IN BOLD ARE AVAILABLE THROUGH ROLA-CHEM.